

## Color Changing LED RGB Full Color Flood Light DC12V 20W DMX







## RGB DC12V 20W

ORDER CODE : CFF100

### SPECIFICATION

- 20W
- DC12V
- Full RGB color
- IP67
- 0.6kg
- -30 ~40

### DIMENSION

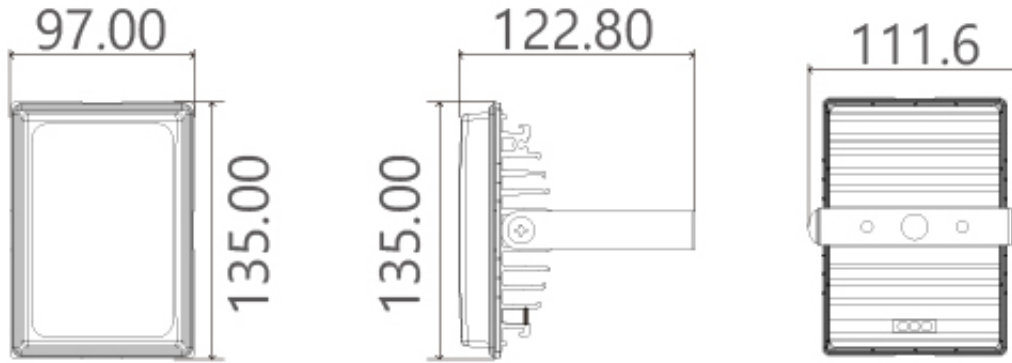

EGM Tech's floodlight uses international patented sealing technology.

And it has high durability that is 100% water-proof, moisture-proof and dust-proof.

For lensed models,

High efficiency total reflection By applying individual lens, we minimize glare and increase light transmission rate to the highest level.

#### 1. World-class sealing (waterproof, moisture-proof) technology

- [Waterproof, moisture proof Technical description](#)

- [US Patent, Korean Patent 1, Korean Patent 2](#)

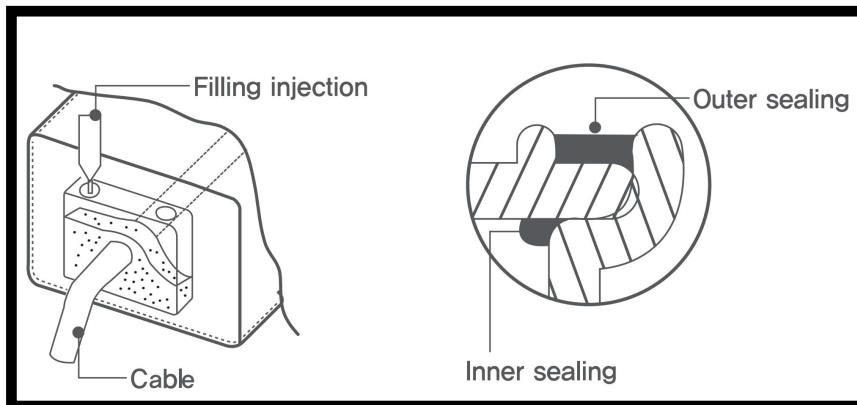

## 2. Used High quality aluminum (AL6063) extruded heat sink used

- Our original designed heat sink, Domestic processing
  - Quality and heat dissipation efficiency are much higher than Chinese die casting method.
  - It can be used in high humidity and high salinity coastal area because it does not rust almost
- due to high quality AL6063 and Coating treatment.

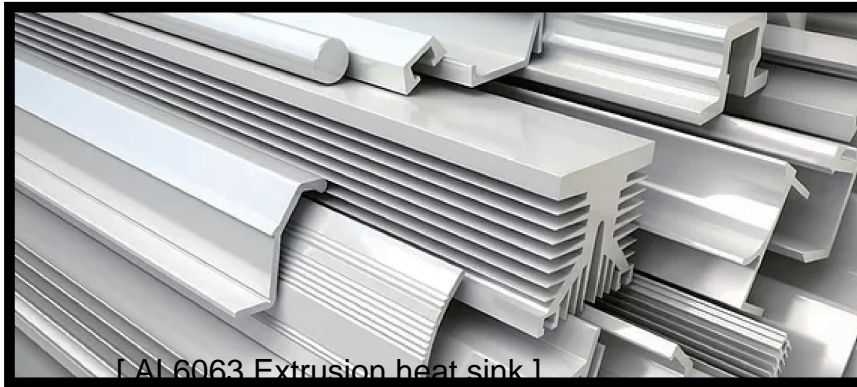

### 3. Used High quality LED, PolyCarbonate , PCB & the Other Component

- Most of the products are Samsung LED or Cree LED, and a few are using Osram LED.

We do not use Chinese LEDs.

- Use high-quality PC materials that are also used for automotive headlights.

Therefore, there is no yellowing caused by UV, and it is not broken well.

- We mainly use FR4 PCB of large and reliable company.

### 4. Proven quality

- We have been in lighting business for more than 9 years,

start work for ships working light

- Cumulative sales of 600,000 units, exported to Japan, Dubai, Italy and Norway

- Antarctica Sejong Station, Norwegian Salmon Farm, Dubai Oil Reservoir

POSCO Pohang Factory, Hyundai Motor Ulsan Factory